

OPUS HE Power Systems

Configurable Cabinet Power Systems

4.5kW – 24kW, 2m/1.6m x 600x600mm, IP20-IP41

Cabinet alternatives:

OC2066 OPUS CABINET
 OC1666 OPUS CABINET
 IC2066 INDUSTRIAL CABINET
 IC1666 INDUSTRIAL CABINET
 RC2066 RITTAL VX25 CABINET

Power Core alternatives:

OPUS HE 24-4.5 PC66 F
 OPUS HE 24-9.0 PC66 F
 OPUS HE 24-18.0 PC66 F
 OPUS HE 48/60-6.0 PC66 F
 OPUS HE 48/60-12.0 PC66 F
 OPUS HE 48/60-24.0 PC66 F
 OPUS HE 110/125-6.0 PC66 F
 OPUS HE 110/125-12.0 PC66 F
 OPUS HE 110/125-24.0 PC66 F
 OPUS HE 220-6.0 PC66 F
 OPUS HE 220-12.0 PC66 F
 OPUS HE 220-24.0 PC66 F



Battery fuses for 1-3 strings, internal or external battery



MCB, MCCB or Switch Fuse/NH00-NH01

DC circuit options



Blocking diode, dropping diode, BLVD/LLVD, A+B system, batt test kit

Configurable Load distribution

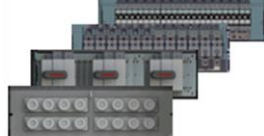

Product Description

OPUS HE power systems are robust, free convection cooled, n+1 redundant backup power solutions for critical infrastructure applications such as power distribution substations, power plants, railway signalling and substations, process industries and telecommunications.

OPUS HE Cabinet power systems consist of MHE rectifiers, VID12 controllers, AC and DC circuit connections, battery protection circuit and load distribution fuses or MCBs. System is fully configurable allowing to choose the best matching cabinet size & type, cable routing, IP rating, quantity of rectifiers, battery fuses, battery shelves, load distribution, load diodes and many other features according to the requirements of the application.

System can be remote monitored by 12 configurable relay alarms or via modern communication protocols such as Ethernet TCP/IP, Modbus TCP/IP, SCADA IEC61850, SNMP and RS-232.

Features

- Efficiency up to 97%
- Convection cooling – no fans
- Outputs 24, 48, 60, 110, 125, 220 VDC
- Flexible design with full front cabling
- VID12 controller, local and remote interfaces
- 12 x relays, Ethernet, Modbus, IEC61850, SNMP, RS-232
- Cabinet selectable per order: OC OPUS cabinet, IC industrial cabinet and RC Rittal cabinet.
- Configurable battery shelves, battery connection and load distribution
- Options: IP21-IP41, BLVD contactor, battery block voltage monitoring, inverters & DC/DC converters
- Safety: EN61439-1/-2, IEC62368-1, EN 50124-1
- EMC: Rectifiers: EN 61000-6-1 / -2 / -3 / -4 / -5
EN 50121-4/-5 rail, ETSI EN 300386 (48/60V)

Technical Specifications

General construction		Environment and standards	
Cooling	Natural convection	Temp. range	-25 ... +60°C, see derating page 5, Start-up at -40°C
Protection	IP 20 – IP41	Humidity max	95% relative humidity, non-condensing
Controller user interface	Display and local control in front door & web interface	Altitude	Max 3km, full power up to 2km above sea level Derating 2% per 100 m between 2-3km
Cabling	Default top entry Option bottom entry	Safety	Cabinet: EN61439-1, EN61439-2 Rectifiers: EN 62368-1, EN 50124-1 rail
Colour	Frame RAL 7037, door RAL 7024	EMC	Cabinet: EN61439-1, EN61439-2 Rectifiers: EN61000-6-1 / -2 / -3 / -4 Generic EN61000-6-5 Utility, surge level 2 EN 50121-4/-5 Rail, ETSI EN 300 386 (48/60V)
Dimensions	Height 2000 mm or 1600 mm (2052 mm incl. adjustabe legs) Width 600 mm Depth 600 mm		

AC Input	
AC connection	TN-S system, 3W + N + PE, (3-phases, neutral and protective earth wires)
Nominal input	220-240 VAC / 3 x 380-415 VAC TN-S system (options: 1-p 100-250VAC or Delta/IT e.g. 3 x 208VAC)
Input range	Max range: 85 – 300 VAC / 3 x 147–528 VAC Rated full power range: 180 – 275 VAC / 3 x 312–476 VAC (TN-S system) See derating curves below, 1200W per rectifier at 120VAC Temporary high voltage range 275 - 300VAC / 3 x 476 - 528VAC, continuous supply not recommended
Input frequency	Rated 45 - 66 Hz, reduced power at 35 - 45 Hz. Shut down at 35 Hz
Main Switch	63A, 4-pole (L1-L2-L3-N)
Rectifier input protection	MCB C16A / rectifier module
	24V 4.5kW 48V 6kW 60V 6kW 110V 6kW 125V 6kW 220V 6kW
Nominal current	8A @ 220/380V 11A @ 220/380VAC
Maximum phase current	12,5A @ 85-130V 12,5A @ 85-180VAC
Recommended mains fuse	3 x 25 A (TN-S)
	24V 9kW 48V 12kW 60V 12kW 110V 12kW 125V 12kW 220V 12kW
Nominal current	16A @ 220/380V 22A @ 220/380VAC
Maximum phase current	25A @ 85-130V 25A @ 85-180VAC
Recommended mains fuse	3 x 25 A (TN-S)
	24V 18kW 48V 24kW 60V 24kW 110V 24kW 125V 24kW 220V 24kW
Nominal current	32A @ 220/380V 44A @ 220/380VAC
Maximum phase current	50A @ 85-130V 50A @ 85-180VAC
Recommended mains fuse	3 x 50 A (TN-S)

DC Output	24V	48V	60V	110V	125V	220V
Grounding	2-pole, floating					
Nominal voltage	24 VDC	48 VDC	60 VDC	108 VDC	120 VDC	216 VDC
Voltage factory setting, 2.27vpc	27.24 VDC	54.48 VDC	68.10 VDC	122.58 VDC	136.20 VDC	245.16 VDC
Voltage range	21-33 VDC	42-59 VDC	51-72 VDC	90-150 VDC	100-160 VDC	178-280 VDC
Static voltage regulation	± 2 % @ load terminals (load, line, temp)			± 1 % @ load terminals (load, line, temp)		
Rectifier output protection	MCB C63A	MCB C50A	MCB C40A	MCB C20A	MCB C20A	MCB C10A
	24V 4.5kW	48V 6kW	60V 6kW	110V 6kW	125V 6kW	220V 6kW
Quantity of rectifiers	Max 3 pcs					
Max current	187.5A @ 24V	125A @ 48V	100A @ 60V	55.5A @ 108V	50A @ 120V	27.8A @ 216V
Max Power	4.5kW	6kW	6kW	6kW	6kW	6kW
	24V 9kW	48V 12kW	60V 12kW	110V 12kW	125V 12kW	220V 12kW
Quantity of rectifiers	Max 6 pcs					
Max current	375A @ 24V	250A @ 48V	200A @ 60V	111A @ 108V	100A @ 120V	55.5A @ 216V
Max Power	9kW	12kW	12kW	12kW	12kW	12kW
	24V 18kW	48V 24kW	60V 24kW	110V 24kW	125V 24kW	220V 24kW
Quantity of rectifiers	Max 12 pcs					
Max current	750A @ 24V	500A @ 48V	400A @ 60V	222 A @ 108V	200A @ 120V	111A @ 216V
Max Power	18kW	24kW	24kW	24kW	24kW	24kW

Battery Connection alternatives

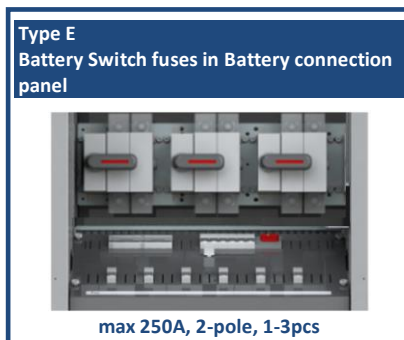
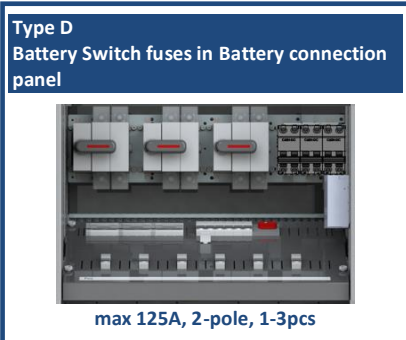
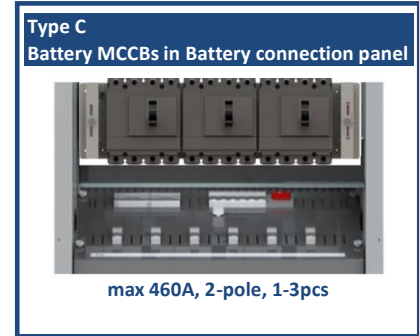
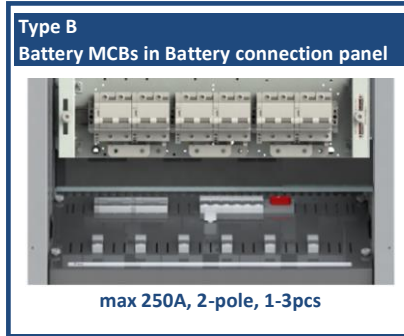
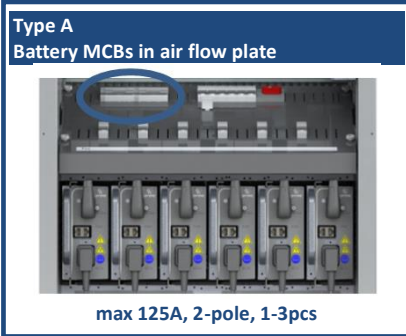

6kW (4.5kW) cabinets	24V 4.5kW	48V 6kW	60V 6kW	110V 6kW	125V 6kW	220V 6kW
MCB battery fuse	Type A MCB D125A 2-pole, 1-3pcs	Type A MCB D125A 2-pole, 1-3pcs	Type A MCB D125A 2-pole, 1-3pcs	Type A MCB D63A 2-pole, 1-3pcs	Type A MCB D63A 2-pole, 1-3pcs	Type A MCB D63A 2-pole, 1-3pcs
Switch fuse battery fuse	Type D NH00 125A 2-pole, 1-2pcs	Type D NH00 125A 2-pole, 1-2pcs	Type D NH00 125A 2-pole, 1-2pcs	Type D NH00 63A 2-pole, 1-2pcs	Type D NH00 63A 2-pole, 1-2pcs	Type D NH00 63A 2-pole, 1-2pcs
Battery shelves	Configurable, 0/1/2/3/4 shelves, 4 height variants 245/275/305/335mm, width 530mm, depth 595mm					

12kW (9kW) cabinets	24V 9kW	48V 12kW	60V 12kW	110V 12kW	125V 12kW	220V 12kW
MCB/MCCB battery fuse	Type B or C MCCB 368A or MCB D250A 2-pole, 1-3pcs	Type B MCB D250A 2-pole, 1-3pcs	Type B MCB D250A 2-pole, 1-3pcs	Type A MCB D125A 2-pole, 1-3pcs	Type A MCB D125A 2-pole, 1-3pcs	Type A MCB D63A 2-pole, 1-3pcs
Switch fuse version	Type E NH01 250A 2-pole, 1-3pcs	Type E NH01 250A 2-pole, 1-3pcs	Type E NH01 250A 2-pole, 1-3pcs	Type D NH00 125A 2-pole, 1-2pcs	Type D NH00 125A 2-pole, 1-2pcs	Type D NH00 63A 2-pole, 1-2pcs
Battery shelves	Configurable, 0/1/2/3/4 shelves, 4 height variants 245/275/305/335mm, width 530mm, depth 595mm					

24kW (18kW) cabinets	24V 18kW	48V 24kW	60V 24kW	110V 24kW	125V 24kW	220V 24kW
MCB/MCCB battery fuse version	Type C MCCB 460A 2-pole, 1-3pcs	Type C MCCB 460A 2-pole, 1-3pcs	Type C MCCB 460A 2-pole, 1-3pcs	Type B MCB D250A 2-pole, 1-3pcs	Type B MCB D250A 2-pole, 1-3pcs	Type A MCB D125A 2-pole, 1-3pcs
Switch fuse version	N/A	N/A	N/A	Type E NH01 250A 2-pole, 1-3pcs	Type E NH01 250A 2-pole, 1-3pcs	Type D NH00 125A 2-pole, 1-2pcs
Battery shelves	Configurable, 0/1/2 shelves, width 530mm, depth 595mm					

Battery test option	MCB for external discharging test load
---------------------	----------------------------------------

Load Distribution alternatives



MCB panels



NH00/NH01 fuse panels



Diazed fuse panels



Cylinder fuse panels

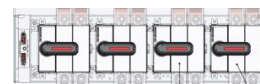

Switch fuse panels

Type	Name	Description
8320X0015692	Bulk Output Terminal XL1	Bulk Output Terminal XL1 Screw terminal 95mm ² 2 x 2-p, top of cabinet (wired)
	Series diode (Blocking diode) module	Semikron 160A, SKKD 162/16, heatsink P3/180
	Dropping diode modules	Semikron 50A - 160A, see configurators
9200X0009815	LD6HF12MCB	Load Distribution panel 12xMCB 2-pole Max DC voltage 250VDC per pole Schneider C60H-DC series Enedo FMU fuse monitoring card
9200X0009819	LD6HF10MCB+AUX	Load Distribution panel 10xMCB 2-pole + aux contact Max DC voltage 250VDC per pole Schneider C60H-DC series
9200X0011397	LD6LF12MCB	Load Distribution panel 12xMCB 2-pole Max DC voltage 72VDC Schneider iC60N series Enedo FMU fuse monitoring card
9200X0015243	LD6LF10MCB+AUX	Load Distribution panel 10xMCB 2-pole + aux contact Max DC voltage 72VDC Schneider iC60N series
9200X0009814	LD6LG24MCB	Load Distribution panel 24xMCB 1-pole Max DC voltage 72VDC Schneider iC60N series Enedo FMU fuse monitoring card
9200X0015239	LD6 230AC 10 x MCB L+N+AUX	Load Distribution panel 10xMCB 2-pole + aux contact AC 230V distribution Schneider iC60N series
920X002000	LD6HF6 6xNH00 2-P HV	Load Distribution panel 6xNH00 2-pole Max 250VDC per pole, Enedo FMU fuse monitoring card
D02323	LD6LG12NH00 12xNH00 1-P LV	Load Distribution panel 12xNH00 1-pole Max 72VDC per pole, Enedo FMU fuse monitoring card
D02355	LD6HF6NH00 BATTERY CENTRAL 6xNH00 2-P HV	Battery Central panel, 6 x positive, 6 x negative, NH00 No fuse monitoring
D02080	SWF 4 x OS125 HV	Load Distribution panel 4 x Switch fuse/NH00 2-pole Fuse monitoring by aux MCB
9200X0009817	LD6HF8DIAZ	Load Distribution panel 8 x Diazed fuse 2-pole Enedo FMU fuse monitoring card
832X015887	LCF14 HV 2-p 3xNH01	Load Distribution panel 3xNH01 2-pole Max 250VDC per pole, Enedo FMU fuse monitoring card
9200X0007374	LCF12 LV 2-P 3xNH01	Load Distribution panel 3 x NH01 2-pole Max 72VDC per pole, Efore DFM fuse monitoring card Max total current 400A
9200X0010650	LCF16 HV 2-p 12xE92/32PV	Load Distribution panel 12 x Cylinder fuse 10x38 mm 2-pole Enedo DFM fuse monitoring card
	Load panel screw terminal options	Screw terminals for load outputs 6-16mm ² , see alternatives in configurators or in price list.

Connection terminals

Mains terminal	Mains input screw terminal blocks 10 mm ² , L1-L2-L3-N-PE
DC output	See alternatives above, connection to screw terminals or to protection device directly
Battery	See battery connection alternatives Internal battery in cabinet: battery cables included External battery: Screw terminals, top of cabinet (wired)
Alarms, Inputs	Configurable relay alarms 12 pcs, Spring terminals 0.75mm ² ... 1.5mm ² cable Configurable alarm/temp. inputs 12 pcs, Spring terminals 0.75mm ² ... 1.5mm ² cable
Battery test terminals	MCB screw terminals
A+B parallel supply	MCB screw terminals

Derating curves

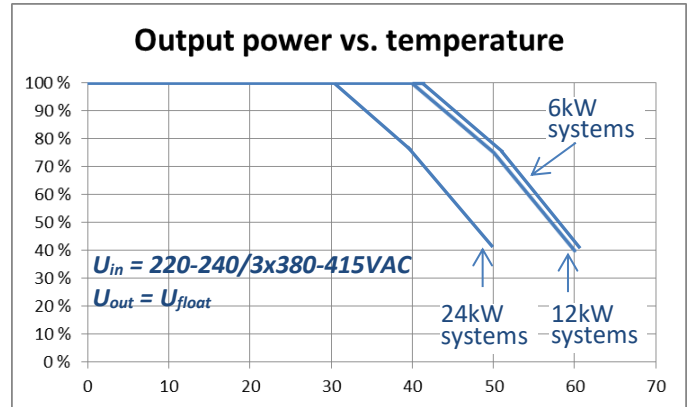
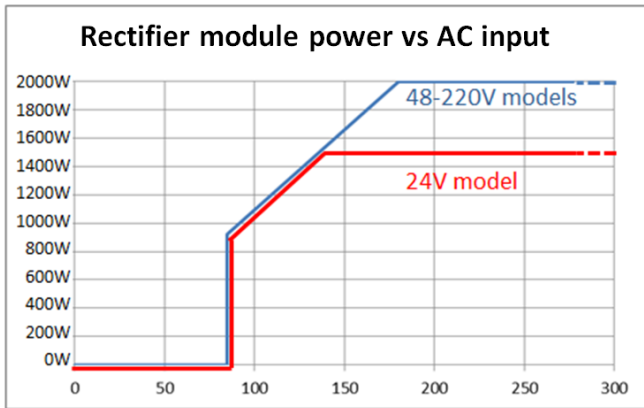

*) Derating curves are continuous power
Short time (<1h) 100% power up to +50°C

Block Diagram, Configurable cabinet options

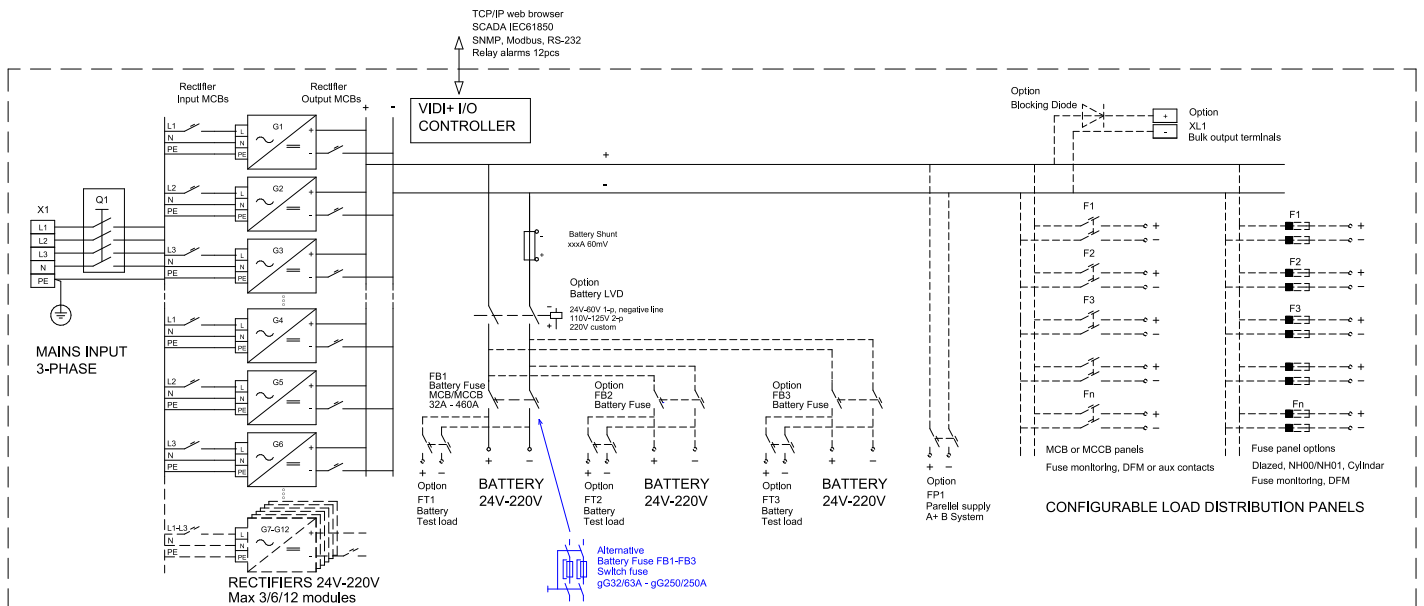

Block Diagram, Example configuration A+B system, inverter and DC/DC converter options

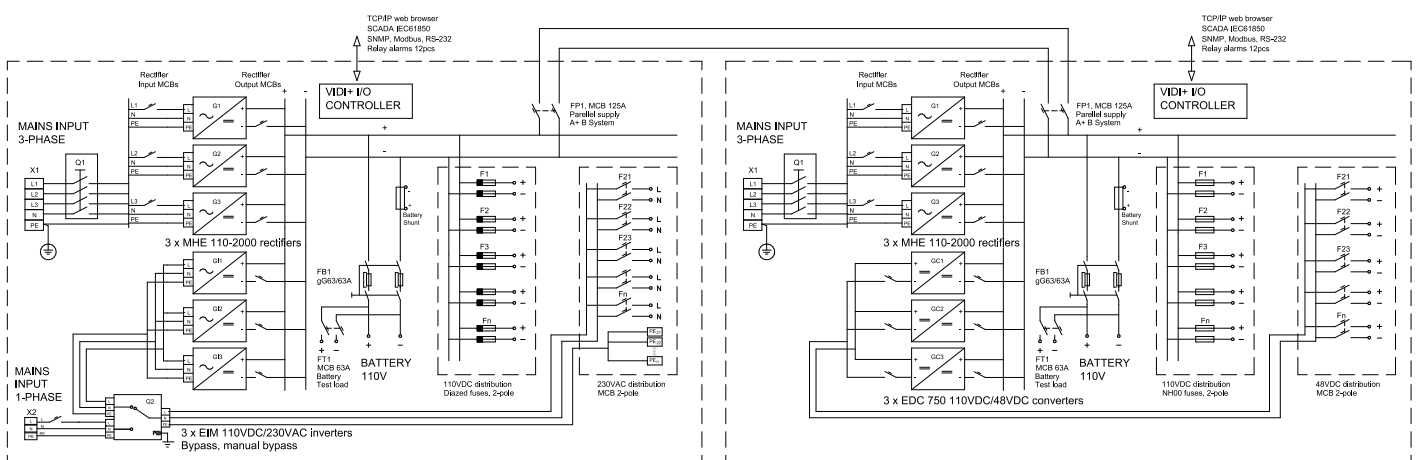

Layout examples, OPUS cabinet systems



OPUS HE 24-18.0 OC2066
24VDC 62.5A – 750A
2 x MCCB 460A battery fuses
Battery & distribution space



OPUS HE 220-12.0 OC2066
220VDC 9.3A – 55.5A
2 x MCB 63A battery fuses
Battery & distribution space



OPUS HE 110-6.0 OC2066
110VDC 18.5A – 111A
Inverter AC power up to 3.6kW
2 x Switch Fuse 125A batt fuses
Battery & distribution space



OPUS HE 48-6.0 OC2066
48VDC 41.7A – 125A
DC/DC Converter up to 3 x 750W
2 x MCB 125A battery fuses
Battery & distribution space



OPUS HE OC0864 Wall Cabinet
24-220VDC 1.5-12kW
External batteries
Inverter and DC/DC Converter
options

Application examples: Master-Slave Cabinet 48kW Cable Entry options top/bottom/side, IP class options IP20 ... IP41



Order Information

Power Core alternatives Power & voltage variants	Order Number	Voltage / Current	Voltage / Current	Qty of MHE rectifiers
OPUS HE 24-4.5 PC66 F	922XW14580	24VDC / 62.5A – 187.5A		1–3 x MHE 24-1500
OPUS HE 24-9.0 PC66 F	922XW11284	24VDC / 62.5A – 375A		1–6 x MHE 24-1500
OPUS HE 24-18.0 PC66 F	922XW11285	24VDC / 62.5A – 750A		1–12 x MHE 24-1500
OPUS HE 48/60-6.0 PC66 F	922XW14581	48VDC / 41.7A – 125A	60VDC / 33.3A – 100A	1–3 x MHE 48-2000 / MHE 60-2000
OPUS HE 48/60-12.0 PC66 F	922XW11266	48VDC / 41.7A – 250A	60VDC / 33.3A – 200A	1–6 x MHE 48-2000 / MHE 60-2000
OPUS HE 48/60-24.0 PC66 F	922XW11267	48VDC / 41.7A – 500A	60VDC / 33.3A – 400A	1–12 x MHE 48-2000 / MHE 60-2000
OPUS HE 110/125-6.0 PC66 F	922XW14582	110VDC / 18.5A – 55.5A	125VDC / 16.7A – 50A	1–3 x MHE 110-2000 / MHE 125-2000
OPUS HE 110/125-12.0 PC66 F	922XW15483	110VDC / 18.5A – 111A	125VDC / 16.7A – 100A	1–6 x MHE 110-2000 / MHE 125-2000
OPUS HE 110/125-24.0 PC66 F	922XW11274	110VDC / 18.5A – 222A	125VDC / 16.7A – 200A	1–12 x MHE 110-2000 / MHE 125-2000
OPUS HE 220-6.0 PC66 F	922XW15784	220VDC / 9.3A – 27.8A		1–3 x MHE 220-2000
OPUS HE 220-12.0 PC66 F	922XW11279	220VDC / 9.3A – 55.5A		1–6 x MHE 220-2000
OPUS HE 220-24.0 PC66 F	922XW11280	220VDC / 9.3A – 111A		1–12 x MHE 220-2000

Cabinet Frame alternatives	Order Number	Dimensions
OC2066 OPUS Cabinet, IP20-IP21	D02555	H 2000mm x W 600mm x D 600mm, + feet / plinth + roof
OC1666 OPUS Cabinet, IP20-IP21	D02556	H 1600mm x W 600mm x D 600mm, + feet / plinth + roof
IC2066 Industrial Cabinet, welded frame, lifting eyes, IP20-IP31	D02559	H 2000mm x W 600mm x D 600mm, + feet / plinth + roof
IC1666 Industrial Cabinet, welded frame, lifting eyes, IP20-IP31	D02560	H 1600mm x W 600mm x D 600mm, + feet / plinth + roof
RC2066 Rittal VX25 Cabinet, robust structure, IP20-IP41	D02674	H 2000mm x W 600mm x D 600mm, + feet / plinth + roof

Cabinet Door alternatives	Order Number	Dimensions
OC2066/IC2066 Cabinet door, standard UIF	8160X0008995	H 2000mm x W 600mm
IC2066/OC2066 Cabinet door, 4 way locking, standard UIF	D02422	H 2000mm x W 600mm
OC1666/IC1666 Cabinet door, standard UIF	8160X0008993	H 1600mm x W 600mm
OC2066/IC2066 Cabinet door, no UIF Intended for battery Cabinets and Slave Cabinets	8160X0008994	H 2000mm x W 600mm

Battery shelf alternatives, Cabinet roof / IP class alternatives, Cable entry alternatives

See price list and configurators

AC supply side configuration

Over voltage protection, 3-phase/2-phase/1-phase supply, Input transformers
See price list and configurators

DC circuit configuration

A+B parallel supply, Load LVD, Blocking diodes, Dropping diodes, Rectifier 1-pole/2-pole protection & aux
See price list and configurators

Battery supply configuration

Battery fuses MCB/MCCB/Switch fuse, Battery testing KIT, Battery LVD, Battery midpoint monitoring, Battery block voltage monitoring, Battery temp. monitoring
See price list and configurators

Control and monitoring

VIDI2 system controller, VIDI2-EFD, VIDI aux controllers, I/O extension KITS
See price list and configurators

Power modules

MHE Rectifiers 24VDC – 220VDC, DAC60000 inverters 24VDC-220VDC / 230VAC, DC/DC converters
See price list and configurators

General options

Wire marking, component marking, packing alternatives
See price list and configurators