

MAIN FEATURES

- Universal input voltage range (85 – 305 V_{AC})
- Input inrush current limiting
- 750 W rated power (1200 W peak for <10 s)
- High efficiency up to 94%
- Single 24 and 48 V_{DC} output voltage available
- Active PFC, EN61000-3-2 compliant (Class C, >25% load)
- Low earth / touch leakage current
- Over temperature, OV, OC and SC protections
- +12 V, 0.3 A; +5 V, 0.72 A Stand-by outputs
- Built-in current sharing and OR-ing for parallel operation and N+1 redundancy
- Remote On / Off signal
- Power good and remote sense signals
- All packages fit 1U applications (1.6" profile)
- ITE safety approval to IEC 62368-1
- Designed to be complied with UL 8750
- RoHS 3 compliant (Directive EU 2015/863)
- 5000 m altitude operation
- PMBus™ digital power-management protocol supported



DESCRIPTION

Rated for IT / Industrial and LED lighting, the DDP1200 UC and PC series of AC-DC power supplies offer increased embedded power in two (2) compact 1U compatible packages, high energy efficiency and wide versatility being optimised for free-air cooling environment.

The series provides a steady 750 W of regulated DC power through 180-305 V_{AC} and 600 W through 90-137 V_{AC} input voltage ranges in a single output of 24 or 48 V_{DC}.

The DDP1200 series come in a U-shaped 1.6" high package (UC) and a variant providing protective vented cage on both AC and DC sides (PC), to facilitate system integration.

By converting AC power at a 94% typical efficiency rate, the DDP1200 series generates very little heat allowing for optimal thermal management.

The series offers a 12 V_{DC}, 0.3 A and a 5 V_{DC}, 0.7 A stand-by outputs and the full set of protection features including high breaking capacity fuses on both AC lines, input under voltage lockout (IUV), output over-current (OC), output short-circuit (SC), output over-voltage (OV) and over-temperature (OT).

The DDP1200 UC and PC series supports digital power management over the PMBus™ communications protocol enabling interoperability with and easy integration into a system. In addition, analogue control signals include Power Good (P_OK), Remote On / Off (+/-PS_Inhibit) and Sense terminals (RS⁺, RS⁻).

Multiple DDP1200 units may be used in parallel mode for redundancy and / or higher power, made possible with the internal OR-ing and current sharing functions.

Being the series conceived and optimised to be operated at free-air cooling environment, therefore without any fan, it is particularly suitable for those environment sensitive to acoustical noise.

The DDP1200 Free Air series complies with the latest IEC/EN/UL 62368-1 safety standard for Audio Video and Information Technologies and was designed to be complied with UL8750.

The DDP1200 Free Air series meets the EN 55032 EMC limits of Class B for conducted and radiated emissions as well as the IEC/EN61000-3 for flicker and harmonics content and the EN 55024, EN 61000-6-2 for EMC immunity.

MARKET SEGMENTS AND APPLICATIONS

- Video Wall Display, Entertainment Lighting
- LED Lighting Engine
- Industrial Control System
- Industrial Laser Applications

MODEL CODING AND OUTPUT RATINGS

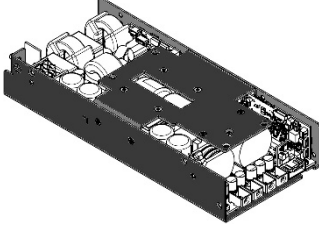
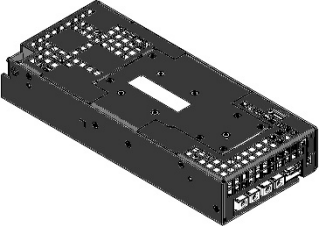
Model Code	Output Voltages	Packages and Cooling	
IT/Industrial Grade: DDP1200	24 VDC: -US24-	 U-Chassis Natural Convection Cooling: -UC	 U-Chassis + Protective Cages Natural Convection Cooling: -PC
	48 VDC: -US48-		

Output Parameter	24 V		48 V	
	180-305 V _{AC} 163-300 V _{DC}	90-137 V _{AC} 120-163 V _{DC}	180-305 V _{AC} 163-300 V _{DC}	90-137 V _{AC} 120-163 V _{DC}
V1 Nom Voltage	24 V _{DC}		48 V _{DC}	
V1 Adjust Range	±5 % V _{NOM}			
V1 Rated Power	750 W	600 W ¹	750 W	600 W ¹
V1 Peak Power (<10 s)	1200 W	1000 W	1200 W	1000 W
V1 Rated Current	31.2 A	25 A	15.6 A	12.5 A
V1 Line Regulation	±0.1 %			
V1 Load Line Cross Regulation	±2 %			
V1 Ripple & Noise	1 % Peak-to-peak			
V1 Transient response	±5 %V1 to 25 % load change at 1 A/μs			
V1 Over Current Protection	<46.8 A		<23.4 A	
V1 Over Voltage protection	116 % V _{NOM} < V _{OUT} < 145 % V _{NOM}			
V1 Max Out Capacitance	16000 μF		8000 μF	
12 V _{SB} Nominal Voltage	12 V _{DC} (stand-by output voltage is referred to the same V1 output voltage return)			
12 V _{SB} Rated Current	0.3 A (maximum +12 V _{SB} and +5 V _{SB} combined output power is 3.6 W)			
12 V _{SB} Ripple & Noise	120 mV Peak-to-peak			
12 V _{SB} Line Cross Regulation	±5 %			
5 V _{SB} Nominal Voltage	5 V _{DC} (stand-by output voltage is referred to the same V1 output voltage return)			
5 V _{SB} Rated Current	0.72 A (maximum +12 V _{SB} and +5 V _{SB} combined output power is 3.6 W)			
5 V _{SB} Ripple & Noise	50 mV Peak-to-peak			
5 V _{SB} Load, line cross Regulation	±5 %			

¹ 540 W @ 85 V_{AC}

INPUT SPECIFICATIONS

Specification	Test Conditions / Notes	Min.	Nominal	Max.	Units
AC Input Voltage	PS starts at 85 V _{AC} at all load conditions Operating input voltage range DDP1200 is designed to operate with a square or trapezoidal input voltage wave form (i.e. from UPS)	85	100-277	305	V _{RMS}
DC Input Voltage	Built in fuses has been safety certified up to 250V _{DC} . Operating the DDP1200 above that limit up to 300 V _{DC} , does require an external fuse protection. (*)	120	-	300	V _{DC}
Input Frequency	400 Hz (max 440 Hz) operation over 85 – 137 V _{AC} input range	47	50/60	63	Hz
Input Current	At 180 V _{AC} , 750 W, 50 / 60 Hz At 85 V _{AC} , 600 W load, 50 / 60 Hz 163 V _{DC} , 750 W 120 V _{DC} , 600 W	-	-	5.0 8.7 5.6 6.0	A _{RMS} A
Inrush Current (peak)	At power-on asserted Cold start, 25 °C ambient, full load Any point of the AC input sine	230 V _{AC} 277 V _{AC}	- -	30 50	A
Fusing²	High breaking, 16 / 20 A, 277 V _{AC} (250 V _{DC}) on each AC lines.	-	-	16 / 20	A
Efficiency	24, 48V variants: At 120 V _{AC} , 20% rated load 50% rated load 100% rated load At 230 V _{AC} , 20% rated load 50% rated load 100% rated load	85 91 92 87 92 94	- - - - - -	- - - - - -	%
Input Power Consumption	At power on, no load, 100-277 V _{AC} range UC/PC Stand by, no load, nominal 100-277 V _{AC} range	-	6.0 3.5	-	W
Power Factor	Any nominal input voltage (except 277V _{AC}), 50/60 Hz, from 50 to 100% maximum load. At 277 V _{AC} .	0.95 0.90	- -	- -	-
THDi	From 50 to 100% rated load, 100-277 V _{AC} , 50/60 Hz	-	-	20 ³	%
Harmonic Current Fluctuations and Flicker	Complies with EN 61000-3-2 at 230 V _{AC} , 50/60 Hz, Class A, D. Complies with EN 61000-3-2 Class C at 230 V _{AC} , 50/60 Hz, >300 W load. Complies with EN 61000-3-3 at nominal voltages and full load.				
Earth Leakage Current	Normal conditions 115 V _{RMS} , 60 Hz 230 V _{RMS} , 50 Hz 264 V _{RMS} , 60 Hz (worst case)	- - -	170 300 -	- - 450	μA
Touch Leakage Current	264 V _{RMS} , 60 Hz Normal Condition (NC) Single Fault Condition (SFC)	- -	- -	100 500	μA
Patient Leakage Current	264 V _{RMS} , 60 Hz Normal Condition (NC) Single Fault Condition (SFC)	- -	- -	100 500	μA

² Suggested fuse SIBA 5012434.16 and fuse holder SIBA 5105805.1

³ 35% max with V1 adjusted between 99.5% to 95% of nominal value

OUTPUT SPECIFICATIONS

Specification	Test Conditions / Notes	Min.	Nom.	Max.	Units
V1 Output Voltages	±0.5 % set point accuracy RS+ closed on +V1, RS- closed on V1 RTN, at 6% load.	-	24 48	-	V
V1 Output Power Rating	UC, PC variants at 180 – 305 V _{AC} UC, PC variants at 85 – 90 V _{AC} UC, PC variants at 90 – 137 V _{AC} Peak, <10 s, after P_Ok asserted high			750 540 600 1200	W
12V_{SB} Output Voltage		-	12	-	V
12V_{SB} Output Current	UC and PC packages up to 70 °C	-	-	0.3	A
5V_{SB} Output Voltage		-	5	-	V
5V_{SB} Output Current	UC and PC packages up to 70 °C	-	-	0.72	A
V1 Voltage Adjustment Range	Manually by push up and down buttons	-	-	±5	%V1
V1 Load-Line-Cross Regulation	V _{AC} : 85 – 305 V _{RMS} ; I ₁ : 0 – 100%	-	-	±2	%V1
5V_{SB}, 12V_{SB} Load-Line-Cross regulation	V _{AC} : 85 – 305 V _{RMS} ; I _{SB} : 0 – 100%	-	-	±5	%V _{SB}
V1 Line Regulation	V _{AC} : 85 – 305 V _{RMS}	-	-	±0.1	%V1
Transient Response:	25 % load changes at 1 A/μs				
V1, 12V_{SB}, 5V_{SB} Voltage Deviation	24 V _{DC} at 1000 μF load / I _{OUT} > 2.5 A 48 V _{DC} at 560 μF load / I _{OUT} > 1.25 A 12 V _{SB} , 5 V _{SB} at 0-2200 μF load	-	-	±5	%V1 %V _{SB}
V1 Ripple and Noise	Rated load, Peak-to-peak, 20 MHz BW. (100 nF ceramic, 10 μF tantalum at load)	-	-	1	%V1
V1 Start-up Rise Time	85<V _{IN} <305, any load conditions	10	-	150	ms
Start-up Delay	V1 in regulation after de-asserting PS_Inhibit V1 in regulation after AC is applied (worst case: 85 V _{AC}) 5V _{SB} in regulation after AC is applied (worst case: 85 V _{AC})	-	-	1700 2200 500	ms
Turn-on Overshoot		-	-	10 10	%V1 %V _{SB}
V1 Hold-up Time	At nominal V _{IN} , full load SEMI F47-0706 compliant at ≥208 V _{AC} 50 % sag (104 V) 30 % sag (145 V) 20 % sag (166 V)	20	-	-	ms
Minimum Load	V1, 12 V _{SB} , 5 V _{SB}	0	-	-	A
Maximum Load Capacitance	V1: 24 V _{DC} V1: 48 V _{DC}	-	-	16000 8000	μF
V1 Current Sharing Accuracy	Parallel operation up to four units. Two units in parallel at I1 rated load. I-Share signals connected together. RS+, RS- signals connected together and to the load. Max load at start up 750 W, operating 1250 W, 180÷305 V _{AC} Max load at start up 600 W, operating 1000 W, 85÷137 V _{AC}	40	-	60	%I1
V1 Remote Sense	RS+ and RS- power path voltage loss compensation	-	-	0.36	V

OUTPUT POWER DE-RATING CURVES

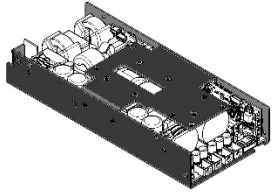
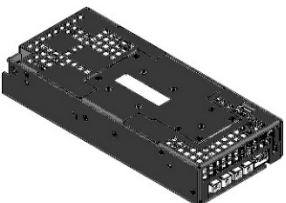
<p>U-Chassis Natural convection cooling (UC) Horizontal mounting</p> 	<p>U-Chassis with Protective Cover Natural convection cooling (PC) Horizontal mounting</p> 
---	---

V1 P_{OUT} to T_{AMB}

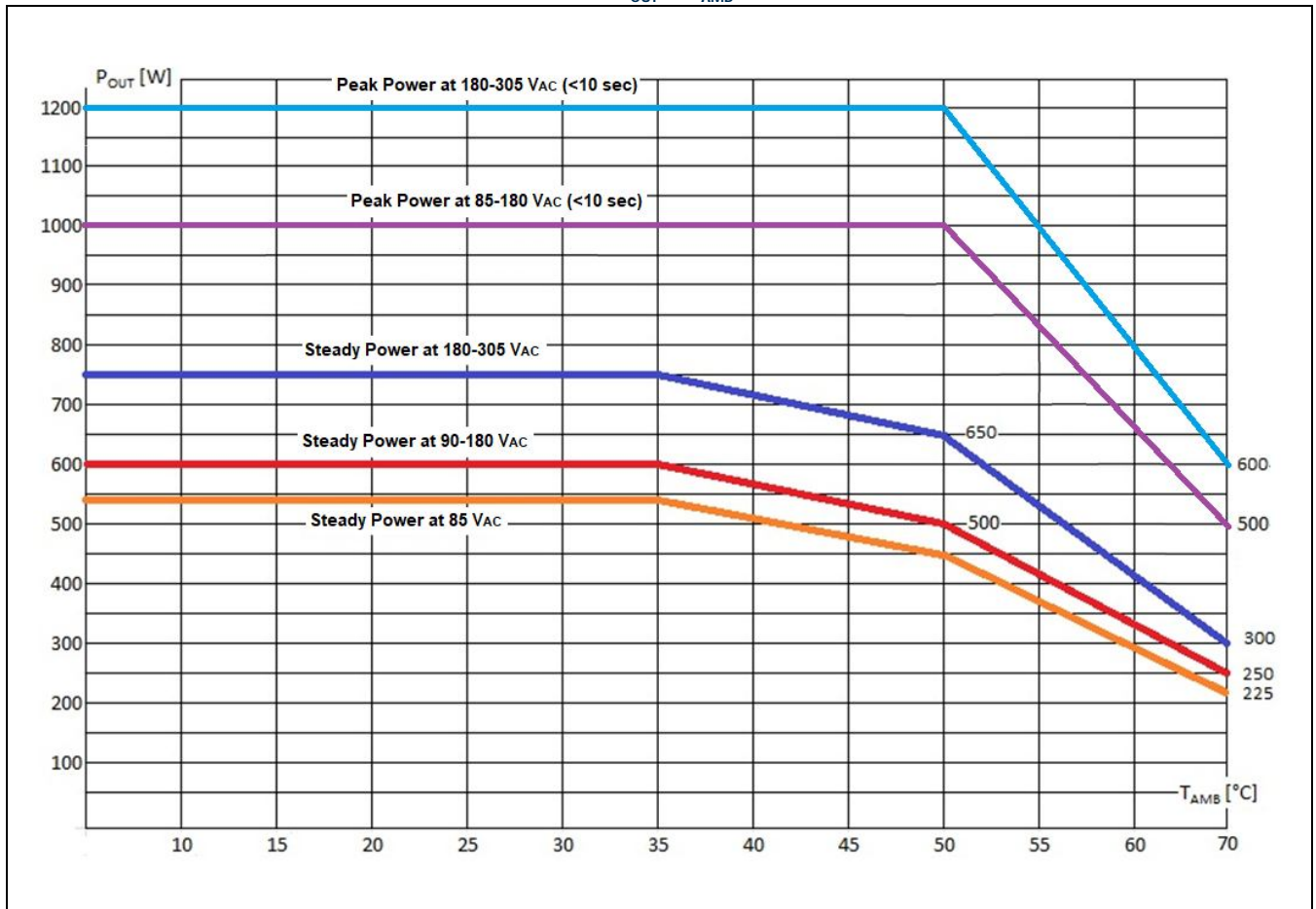

PMBus

The DDP1200 does support communication according the PMBus 1.2 protocol via SDA, SCL and #SMBALERT signals as defined in the SMBus Specification version 2.0.

The power supply shall not load the SMBus if it has no input power (SCL & SDA lines should go to High-Z).

The pull-up resistors (2.2 k Ω) for these signals shall be external to the power supply and referenced to an external +3.3V bus voltage.

The DSP circuits inside the power supply are powered by the standby output.

The PMBus is active whatever input power is applied to the power supply or a parallel redundant power supply in the system, provided that their 12V_{SB} are connected in parallel.

Maximum speed of SMBus is 100 kHz.

The ADDR0 and ADDR1 signals, are inputs to the power supply that control the PMBus address assigned to the power supply.

On the system side, the ADDR0 and ADDR1 signals will either be connected to return through a 1 k Ω pull-down resistor or connected to +3.3V external bus voltage through a 1 k Ω pull-up resistor.

The address shall be derived from the logic of this pin as indicated on Outline Drawing and Connections section.

The power supply is a slave only on SMBus device.

For a comprehensive description of DDP1200 PMBus management, do refer to the application note, "AN_MDP-DDP1200 PMBus Mgt". Examples of DDP1200 parameters available through communication bus are:

- Input voltage status
- Output voltages +V1 measured value
- Output current on +V1 measured value
- Current sharing status
- Thermal health measured value
- Power-On / Working hours
- Product information
- Status information

Failures shall be reported by PMBus for all failure types:

- Protections failure (OV, OC, OT)
- Voltages out of specification.

BASE SIGNALS / CONTROLS (ACCESSIBLE FROM SIGNAL CONNECTOR P204)

Signal	Notes	Min	Typ.	Max	Unit
+PS_Inhibit (Active High)	Input low voltage ($I_{IN}= 0 \mu A$)	0	-	0.8	V
	Input high voltage ($I_{IN}= 500 \mu A$ at 5.5 V)	2.5	-	5.5	
-PS_Inhibit (Active Low)	V1 disabled when PS_Inhibit is pulled high				
	V1 enabled when PS_Inhibit is floating or low				
Power_OK⁴ (PS_OK)	5V _{SB} and 12V _{SB} not affected by PS_Inhibit				
	Input low voltage ($I_{IN}= -800 \mu A$ at 0 V)	0	-	0.8	
I_Share	Input high voltage ($I_{IN}= -200 \mu A$ at 2.5 V)	2.5	-	5.5	V
	($I_{IN}= 700 \mu A$ at 5.5 V)				
SDA, SCL, #SMBALERT, ADDR0, ADDR1	V1 disabled when -PS_Inhibit is pulled low				
	V1 enabled when -PS_Inhibit is floating or high				
RSVD RX, RSVD TX	5V _{SB} and 12V _{SB} not affected by -PS_Inhibit				
	Logic level low (<10 mA sinking)	-	-	0.7	
5V_{SB} Output⁵	Logic level high (200 μA sourcing)	2.4	-	3.45	V
	Low to high time after V1 in regulation	150	-	350	
12V_{SB} Output⁶	Power down warning time	2	-	-	ms
	The I_SHARE signals shall be daisy chained among power supplies operating in parallel.				
RSVD RX, RSVD TX	On a single power supply operating it provides current measurement on V1 output.				
	On multiple power supplies operating in parallel, it provides current measurement on master V1 output.				
5V_{SB} Output⁵	These are signals which support PMBus communication protocol as specified in the application note AN_MDP-DDP1200 PMBus Mgt_Rev00.				
	Mainly intended for internal Efore use, these RX and TX signals - available at the output signal connector P204 - may be used to access some DSP functions (monitoring, threshold settings, debug functions).				
12V_{SB} Output⁶	These signals work as an UART Rx/Tx port and can also work as a RS-232 Rx/Tx port by building in the "RS-232 LINE DRIVERS/RECEIVERS" IC				
	Active and in regulation after an $85 < V_{AC} < 305$ is applied	-	-	500	
12V_{SB} Output⁶	Not affected by PS_Inhibit. Available on P204, pin#4				ms
	Active and in regulation after an $85 < V_{AC} < 305$ is applied	-	-	500	
12V_{SB} Output⁶	Not affected by PS_Inhibit. Available on P204, pin#16				ms

⁴ When V1 is On, a P_OK low may indicate V1 under voltage condition. When two DDP1200 operate in parallel, P_OK low in one unit indicates that it is not sharing the expected amount of current (current sharing fault). A 3.3 k Ω internal pull up to a 3.3 V internal reference voltage is used; do not add any other external pull up.

⁵ The 5V_{SB} outputs of two or more DDP1200s operating in parallel, cannot be connected in parallel in turn, since doing so results in power supplies damage.

⁶ The 12V_{SB} outputs of two or more DDP1200s operating in parallel can be connected in parallel in turn, taking into account that the maximum available power will not be higher of a single operating power supply one.

BASE SIGNALS / CONTROLS TIMING

AC/DC input Off-to-On and On-to-Off timings:

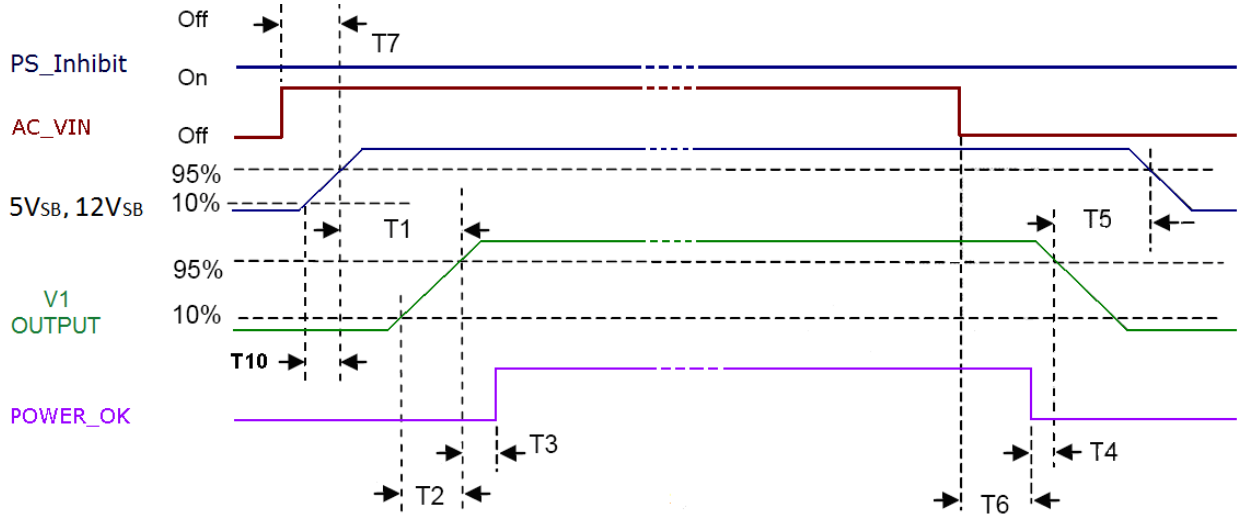

12V _{SB} /5V _{SB} On to V1 On	250 ms ≤ T1 ≤ 1700 ms
V1 rise time	10 ms ≤ T2 ≤ 150 ms
12V _{SB} /5V _{SB} rise time	3 ms ≤ T10 ≤ 150 ms
V1 On – POWER_OK delay	150 ms ≤ T3 ≤ 350 ms
Power down warning	T4 ≥ 12 ms
V1 Off to 12V _{SB} /5V _{SB} Off	T5 ≥ 0.5 s (V1 load > 25 W)
AC Off to POWER_OK low	T6 ≥ 8 ms
AC On to 12V _{SB} /5V _{SB} On	T7 ≤ 500 ms

PS_Inhibit Off-to-On and On-to-Off timings:

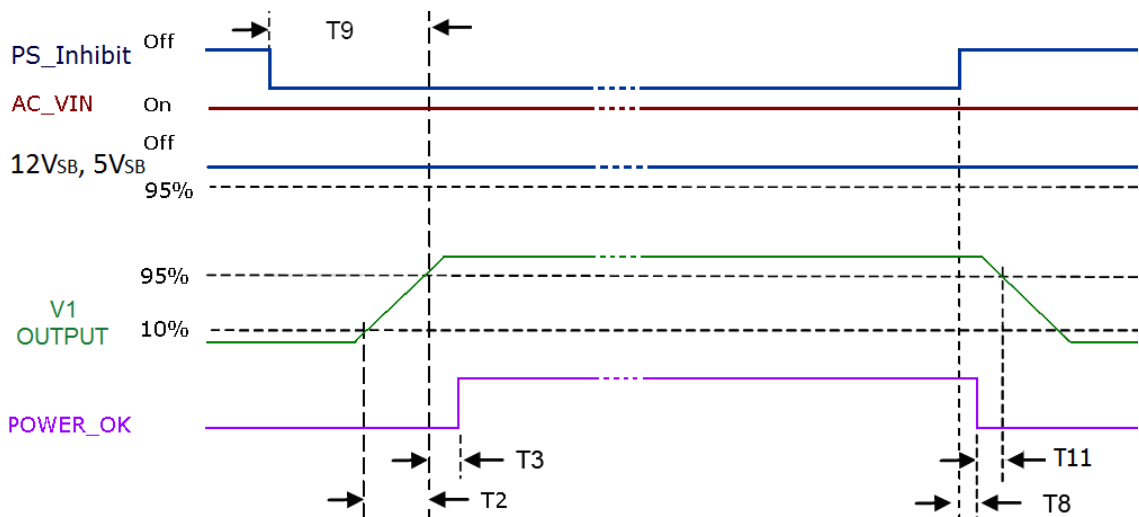

V1 rise time	10 ms ≤ T2 ≤ 150 ms
V1 On – POWER_OK delay	150 ms ≤ T3 ≤ 350 ms
Turn-Off warning	T11 ≥ 1 ms
PS_Inhibit – POWER_OK low delay	T8 ≤ 3 ms
PS_Inhibit – V1 On delay	T9 ≤ 1700 ms

PROTECTION FEATURES

Specification	Test Conditions / Notes	Min.	Nominal	Max.	Units
Input Under Voltage	Auto-recovering, hiccup mode.	58	75	82	V _{AC}
Input Fuse	High breaking, 16 / 20 A, 277 V _{AC} (250 V _{DC}) on each AC lines.	-	-	16/20	A
Over Current	At nominal input voltages	-	-	150	%I _{Rated}
	V1: Hiccup mode, auto-recovering	-	-	-	A
	5 V _{SB} : Auto-recovering	-	-	-	A
	12 V _{SB} : Hiccup mode, auto-recovering	-	-	-	A
Short Circuit	At nominal input voltages	-	-	-	
	V1: Hiccup mode or latch	-	-	-	
	5 V _{SB} : Auto-recovery	-	-	-	
	12 V _{SB} : Hiccup mode, auto-recovering.	-	-	-	
Over Voltage	V1, Power shut down, latch off.	116	-	145	%V _{NOM}
	12 V _{SB} , Hiccup mode, auto-recovering.	-	-	150	
Over Temperature (ambient)	Hiccup mode, auto-recovering.	70	-	-	°C
Over Temperature (on secondary side)	Hiccup mode, auto-recovering.	-	-	-	°C
Isolation: Primary-to-Secondary	Reinforced	5660	-	-	V _{DC}
		4000	-	-	V _{AC}
Isolation: Input-to-Earth	Basic	2642	-	-	V _{DC}
	Production tested at 2642 V _{DC}	1865	-	-	V _{AC}
Isolation: Output-to-Earth	Basic	1500	-	-	V _{AC}
Equipment Protection Class		Class I			

ENVIRONMENTAL SPECIFICATIONS

Specification	Test Conditions / Notes	Min	Nominal	Max	Units
Operating Temperature Range (no De-rating)	No de-rating up to 35 °C See de-rating curves above DDP1200 starts at -40 °C upon warm up delay	-20	-	35	°C
Operating Temperature Range (with De-rating)	See de-rating curves and conditions in the Output Specifications section	-	-	70	°C
Storage Temperature	As per IEC/EN 60721-3-1 Class 1K4	-40	-	85	°C
Transportation Temperature	As per IEC/EN 60721-3-2 Class 2K4	-40	-	85	°C
Humidity	RH, Non-condensing Operating.	-	-	90	%
	Non-operating	-	-	95	%
Operating Altitude	Power de-rating above 1800 m	-	-	4000	m
Shock	EN 60068-2-27				
	Operating: Half sine, 30 g, 18 ms, 3 axes, 6x each (3 positive and 3 negative).				
	Non-Operating: Half sine, 50 g, 11 ms, 3 axes, 6x each (3 positive and 3 negative).				
Vibration	EN 60068-2-64				
	Operating: Sine, 10 – 500 Hz, 1 g, 3 axes, 1 oct/min., 60 min.				
	Random, 5 – 500 Hz, 0.02 g ² /Hz, 1 g _{RMS} , 3 axes, 30 min.				
	Non-Operating: 5 – 500 Hz, 2.46 g _{RMS} (0.0122 g ² /Hz), 3 axes, 30 min.				
MTBF	Full load, 25 °C ambient, 100 % duty cycle,	430.000	-	-	Hours
	Full load, 40 °C ambient, 75 % duty cycle	280.000	-	-	
	Telcordia SR-332 Issue 2				
Useful Life	Nominal V _{IN} , 80 % load, 40 °C ambient (IPC 9592)	-	3	-	Years

ELECTROMAGNETIC COMPATIBILITY (EMC) – EMISSIONS

Phenomenon	Conditions / Notes	Standard	Equipment/Performance Class
Conducted	115, 230, 277 V _{RMS} , Maximum load	EN 55032 EN 55011 (ISM) FCC Part 15	B
Radiated		EN 55032 EN 55011 (ISM) FCC Part 15	B ⁷
Line Voltage Fluctuation and Flicker	At 20%, 50% and 100% maximum load Nominal input voltages	EN 61000-3-3	
Harmonic Current	230 V _{AC} input voltage, 50 / 60 Hz	EN 61000-3-2	A, D
Emission	230 V _{AC} , 50 / 60 Hz, >300 W load	EN 61000-3-2	C

⁷ Performance referred to the enclosed PC package with additional HF chokes on input, output power and signal cables. In any case, radiated emission relevant to both UC and PC package variants, should be assessed at system level.

ELECTROMAGNETIC COMPATIBILITY (EMC) – IMMUNITY

Phenomenon	Conditions / Notes	Standard	Test Level	Criteria
	Reference standard for ITE	EN 55024		
	Reference standard for Industrial/IMS equipment	EN 61000-6-2		
ESD	15 kV air discharge, 8 kV contact, at any point of the system.	EN 61000-4-2	4	A
Radiated Field	10 V/m, 20-2700 MHz, 1 kHz, 80% AM.	EN 61000-4-3	3	A
Electric Fast Transient Surge	±2 kV on AC power port for 1 minute	EN 61000-4-4	3	A
Conducted RF Immunity	±2 kV line to line; ± 3 kV line to earth on AC power port	EN 61000-4-5	X	A
Dips and Interruptions	10 V _{RMS} , 0, 15-80 MHz, 1 kHz, 80% AM	EN 61000-4-6	3	A
	200 – 277 V_{AC}:			
	Drop-out to 0% for 10 ms	EN61000-4-11		A ⁸
	Dip to 40% for 5 cycles (100 ms)	EN61000-4-11		A (de-rate to 500 W)
	Dip to 70% for 25 cycles (500 ms)	EN61000-4-11		A
	Drop-out to 0% for 5 s	EN61000-4-11		B
	100 – 127 V_{AC}:			
	Drop-out to 0% for 10 ms	EN 61000-4-11		A ⁸
	Dip to 40% for 5 cycles (100 ms)	EN 61000-4-11		A (de-rate to 240 W)
	Dip to 70% for 25 cycles (500 ms)	EN 61000-4-11		A (de-rate to 400 W)
	Drop-out to 0% for 5 s	EN 61000-4-11		B

⁸ Performance referred to 5VSB, 12VSB and V1 (PS_OK goes to low level after 8 ms as per timing described at page 8)

SAFETY AGENCIES APPROVALS

Certification Body	Safety Standards and file numbers	Category
CSA / UL	CSA C22.2 No.62368-1, UL 62368-1	Audio Video and Information Technology Equipment
IEC IECEE CB Certification	IEC/EN 62368-1	Audio Video and Information Technology Equipment
	Directive 2014/35/EU: Electrical Safety: Low Voltage electrical equipment (LVD)	Audio Video and Information Technology Equipment
CE	Directive 2014/30/EU: Electromagnetic Compatibility (EMC)	
	Directive EU 2015/863: RoHS 3	
	Meets all essential requirements of the standard IEC/EN/UL/CSA 61010-1 2 nd edition	

OUTLINE DRAWING AND CONNECTIONS – U-CHASSIS (-UC)

Overall dimensions: 101.6 x 234 x 41.0 mm (4.00 x 9.21 x 1.61 in)

Weight: 1087 g (2.40 lb)

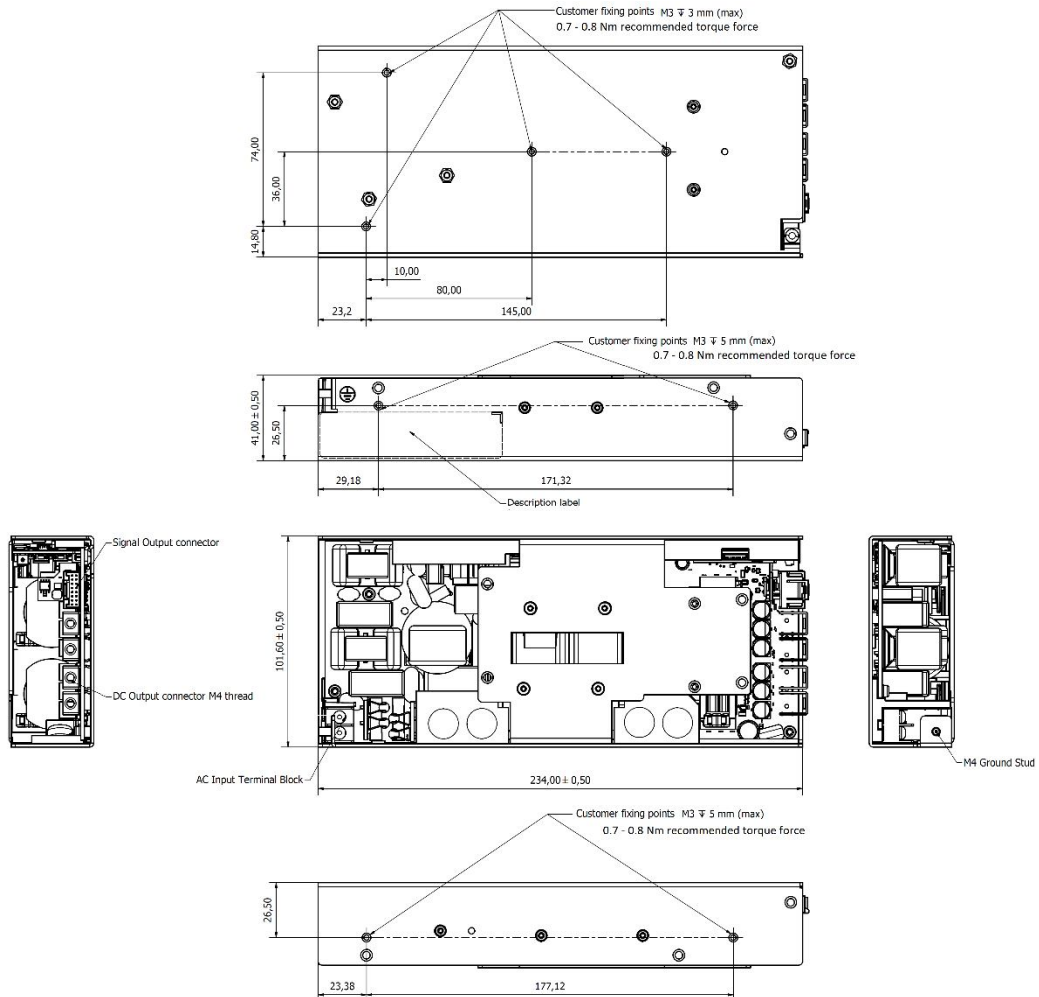

AC INPUT CONNECTIONS		DC OUTPUT CONNECTIONS		SIGNAL CONNECTOR		ADDITIONAL CONTROL FUNCTIONS		
P1: AMTEK TB25C-B02P-13-00A-L M4 GROUND STUD		P200, P201, P202, P203: BRASS M4 THREADED TERMINAL (tight to 0.8-1Nm, max deep screws 7 mm)		P204: MOLEX 501876-1640		SW600, SW601, DL600:		
<p>M4 GROUND STUD</p>								
Ref.	Function	Ref.	Function	Ref.	Function	Ref.	Function	
1	Line 1		24V Optional	24 / 48V	1	RMT (-)	SW600	V1_ADJ (UP)
2	Line 2		+V1	+V1	2	RMT (+)		
3	Protection Earth	P200	+V1	-	3	I-SHARE	SW601	V1_ADJ (DOWN)
		P201	+V1	-	4	+5V _{SB}		
		P202	V1 RTN	V1 RTN	5	PS_INHIBIT	DL600	Bi-colour LED
		P203	V1 RTN	-	6	PS_OK		Off
					7	SCL		No AC/DC input power provided
					8	SDA		
					9	#SMBALERT	Blinking Green	Input power good, standby active, V1 inhibited
					10	ADDR0		
					11	-PS_INHIBIT	Steady Green	V1 Active
					12	ADDR1		
					13	RSVD_RX (OUT)	Steady or Blinking red	Power Supply Fault
					14	RSVD_TX (OUT)		
					15	RTN		
					16	+12V _{SB}		

OUTLINE DRAWING AND CONNECTIONS –U-CHASSIS + PERFORATED COVERS (-PC)

Overall dimensions: 101.6 x 234.7 x 41.0 mm (4.0 x 9.21 x 1.61 in)

Weight: 1125 g (2.48 lb)

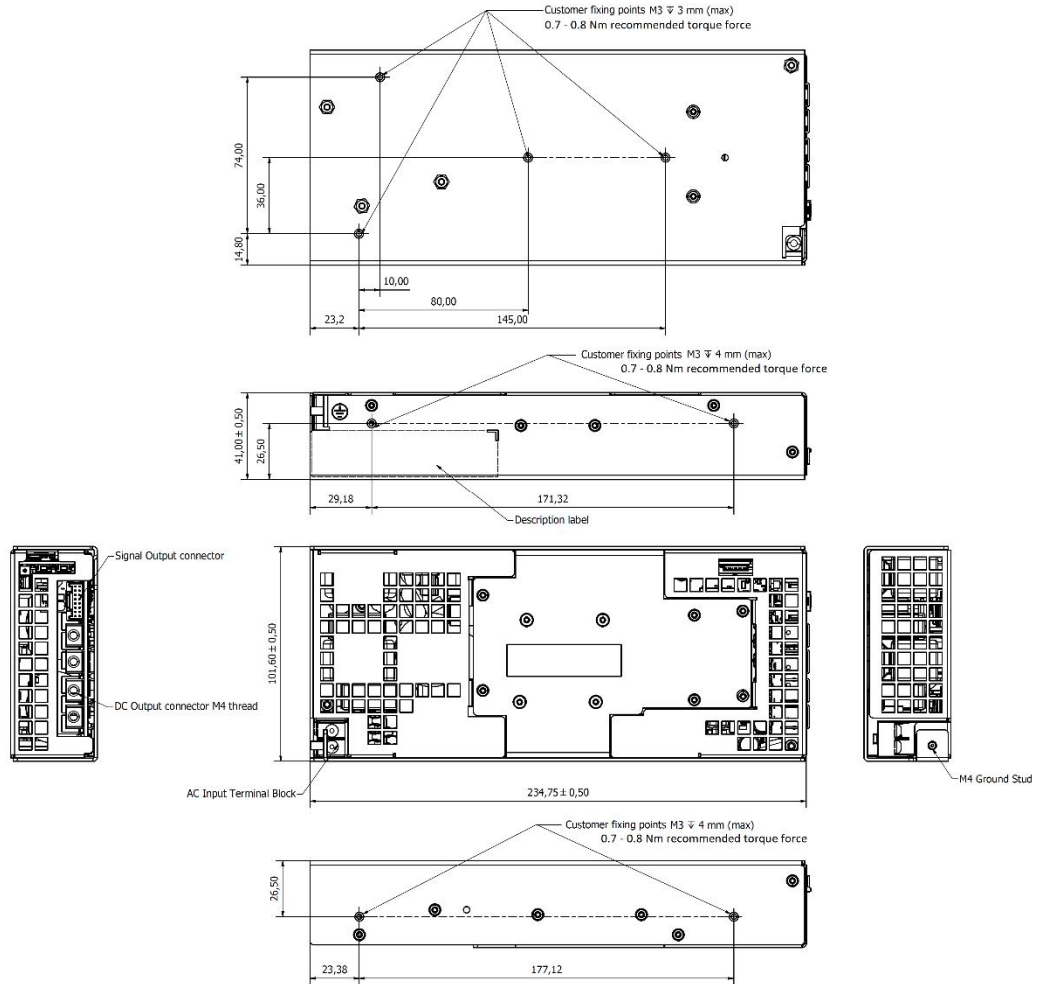

AC INPUT CONNECTIONS		DC OUTPUT CONNECTIONS		SIGNAL CONNECTOR		ADDITIONAL CONTROL FUNCTIONS	
P1: AMTEK TB25C-B02P-13-00A-L M4 GROUND STUD		P200, P201, P202, P203: BRASS M4 THREADED TERMINAL (tight to 0.8-1Nm, max deep screws 7 mm)		P204: MOLEX 501876-1640		SW600, SW601, DL600:	
<p>M4 GROUND STUD</p>		<p>P200 P201 P202 P203 P204</p>		<p>DL600 SW600 SW601</p>			
Ref.	Function	Ref.	Function	Ref.	Function	Ref.	Function
1	Line 1		24V Optional	1	RMT (-)	SW600	V1_ADJ (UP)
2	Line 2		24 / 48V	2	RMT (+)		
3	Protection Earth	P200	+V1	3	I-SHARE	SW601	V1_ADJ (DOWN)
		P201	+V1	4	+5V _{SB}		
		P202	V1 RTN	5	PS_INHIBIT	DL600	Bi-colour LED
		P203	V1 RTN	6	PS_OK		Off
				7	SCL		No AC/DC input power provided
				8	SDA		
				9	#SMBALERT	Blinking Green	Input power good, standby active, V1 inhibited
				10	ADDR0		
				11	-PS_INHIBIT	Steady Green	V1 Active
				12	ADDR1		
				13	RSVD_RX (OUT)	Steady or Blinking red	Power Supply Fault
				14	RSVD_TX (OUT)		
				15	RTN		
				16	+12V _{SB}		

PROTECTION EARTH CONNECTION INSTRUCTIONS

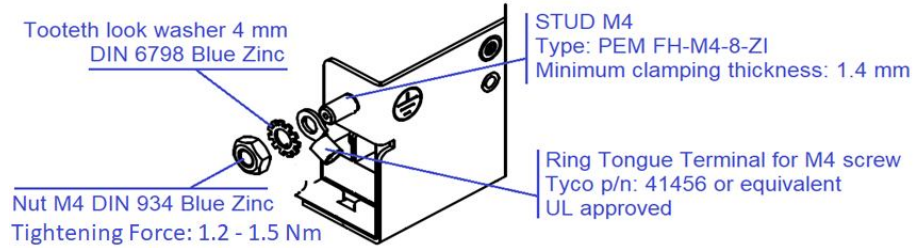

Specifications appearing in ENEDO's catalogues and brochures as well as any oral statements are not binding. All descriptions, drawings and other particulars (including dimensions, materials and performance data) given by ENEDO are as accurate as possible but, being given for general information, and are not binding on ENEDOE. ENEDO makes thus no representation or warranty as to the accuracy of such material. We assume no liability other than as agreed in the terms of the individual contracts and we reserve the right to make technical modifications in the course of our product development. Our product information solely describes our goods and services and is in no way to be construed or interpreted as a quality or condition guarantee. The aforesaid shall not relieve the customer of its obligation to verify the suitability of our Products for the use or application intended by the purchaser. Customers are responsible for their products and applications. ENEDO assumes no liability from the use of its products outside of specifications. No license is granted to any intellectual property rights by this document.