

## DESCRIPTION

DDP400HV is a series of high efficiency, small form factor AC-DC power supplies operating at 277/347/480V<sub>AC</sub> inputs.

The series provides a steady 400 W of regulated DC power through the full input range of 249 to 528 V<sub>AC</sub>. Available in 24, 36 and 48 V models. Each model includes an auxiliary 12V<sub>DC</sub> and 5V<sub>DC</sub> stand-by outputs. Control signals include AC\_OK and remote on/off.

The DDP400HV series comes in an IP67 sealed enclosure with flying leads for both input and output. An optional heat-sink is available or the DDP400HV may be installed directly to the end equipment with heat transferred by conduction.

By converting energy at 93% typical efficiency, the DDP400HV series generates less heat facilitating thermal management in space constrained system and offering high reliability.

Full output power rating from -35 to 50 °C, with operation up to 70 °C with de-rating and is capable to start up from -40 °C.



IP67 c  us 

## KEY FEATURES

- Wide input voltage range (249-528 V<sub>AC</sub>)
- 400 W rated power (420 W peak)
- Extremely high efficiency (93% typical)
- Low stand-by consumption (<2.8 W at 480 V<sub>AC</sub>)
- 24, 36 and 48 V standard output variants
- Active PFC, EN61000-3-2 Class C at >100 W load
- Low earth leakage current
- Over temperature protection
- OV, OC, and short circuit protections
- +5 V, 2 A stand-by output
- +12 V, 1 A auxiliary / fan output
- Remote On / Off and power good signals
- RoHS-6 compliant (EU directive 2011/65/UE)
- 4000 m altitude operation.

## MARKET SEGMENT AND APPLICATIONS

- Large Format Display Power
- Large Venues and Stadium Lighting
- High Powered Street Lighting
- Large Area Parking
- High Bay Industrial Space
- Architectural Lighting
- Outdoor Lighting
- Horticultural Lighting

## MODEL CODING AND OUTPUT RATINGS

Model Grade and Output Power	Output Nominal Voltage	Package/Fan Options
DDP400HV-	24 V <sub>DC</sub> : <b>US24-</b>	Sealed Conduction/Convection Cooling: <b>SC</b>
DDP400HV-	36 V <sub>DC</sub> : <b>US36-</b>	
DDP400HV-	48 V <sub>DC</sub> : <b>US48-</b>	

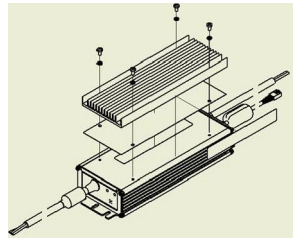
DP400HV	-	US	24	-	SC	Heat-sink can be ordered as an accessory using the code:  <b>RHPS384PH-3</b>  Mounting kit includes 4X screws M4x8, 4X split washer and a thermally conductive graphite sheet	
	36						
	48						

Model Number	V1 [V]	I1 <sup>1</sup> without heatsink [A]	I1 <sup>2</sup> with heatsink [A]	V1 <sup>3</sup> Ripple [mV]	V2 [V]	I2 <sup>1</sup> without heatsink [A]	I2 <sup>2</sup> with heatsink [A]	V2 <sup>3</sup> Ripple [mV]	5V <sub>SB</sub> [V]	I5V <sub>SB</sub> <sup>1</sup> without heatsink [A]	I5V <sub>SB</sub> <sup>2</sup> with heatsink [A]	5V <sub>SB</sub> <sup>3</sup> Ripple [mV]
DDP400HV- US24-SC	24	13.33	16.66	240	12	1	1	240	5	2	2	50
DDP400HV- US36-SC	36	8.88	11.11	360	12	1	1	240	5	2	2	50
DDP400HV- US48-SC	48	6.66	8.33	480	12	1	1	240	5	2	2	50

<sup>1</sup> The combined output power of V1, V2 and 5V<sub>SB</sub> without the optional heat-sink, must not exceed 400W at 25°C, 320W at 50 °C, and 215W at 70 °C ambient temperature (480 V<sub>AC</sub>). See de-rating curves below.

<sup>2</sup> The combined output power of V1, V2 and 5V<sub>SB</sub> with the optional heat-sink must not exceed 400W up to 50°C and 275W at 70°C ambient temperature (480 V<sub>AC</sub>). See de-rating curves below.

<sup>3</sup> Peak-to-Peak measured at 20 MHz Bandwidth.

All ratings in the table above refer to 480 V<sub>AC</sub> and 50°C ambient temperature. In any case, the chassis hot spot temperature T<sub>c</sub> shall never exceed 90 °C

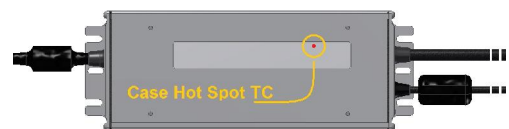

## INPUT SPECIFICATIONS

Specification	Test Conditions / Notes	Min.	Nominal	Max.	Units
<b>AC Input Voltage</b>	PS starts and operates at 249 V <sub>AC</sub> at all load conditions	249	277/347/480	528	V <sub>AC</sub>
<b>DC Input Voltage</b>		300	365	400	V <sub>DC</sub>
<b>Input Frequency</b>		47	50/60	63	Hz
<b>Input Current</b>	RMS at 249 V <sub>AC</sub> , maximum load	-	-	1.8	A
<b>Inrush Current</b>	Peak at 480 V <sub>AC</sub> , cold start, no damage	-	-	60	A
<b>Fusing</b>	2X Time Lag, 500 V <sub>AC</sub> /400V <sub>DC</sub> on ACL1 and ACL2	-	-	5.0	A
<b>Efficiency</b>	480 V <sub>AC</sub> at 20% load	-	89.0	-	%
	480 V <sub>AC</sub> at 50% load	-	92.6	-	
	480 V <sub>AC</sub> at 100% load	-	93.5	-	
	277 V <sub>AC</sub> at 20% load	-	89.6	-	
	277 V <sub>AC</sub> at 50% load	-	92.5	-	
	277 V <sub>AC</sub> at 100% load	-	92.6	-	
<b>Input Power Consumption</b>	Power on, 480 V <sub>AC</sub> , no load	-	3.9	4.5	W
	Stand by, 480 V <sub>AC</sub> , no load	-	2.8	3.3	
<b>Power Factor</b>	From 50% to 100% rated load, 277/347/480 V <sub>AC</sub> , 50 / 60 Hz	0.90	-	-	-
<b>THD</b>	From 50% to 100% rated load, 277/347/480 V <sub>AC</sub> , 50 / 60 Hz	-	-	20	%
<b>Harmonic Current</b>	Complies with EN-61000-3-2 Class C 277/347/480 V <sub>AC</sub> , 50 / 60 Hz, load >100 W				
<b>Fluctuations and Flicker</b>	Complies with EN-61000-3-3 at 277/347/480 V <sub>AC</sub> , 50 / 60 Hz, full load				
<b>Leakage Current</b>	Normal operation, 480 V <sub>AC</sub> , 60 Hz Neutral connected to Earth	-	-	750	µA

## OUTPUT SPECIFICATIONS

Specification	Test Conditions / Notes	Min.	Nom.	Max.	Units
<b>V1 Output Voltage</b>	+RS closed on +V1, 6% rated load 24V (0.5% set point accuracy) 36V (0.5% set point accuracy) 48V (0.5% set point accuracy)	-	24 36 48	-	V
<b>V1 Output Power Rating</b>	All models (see output de-rating curves) Peak (less than 10 seconds, after P_OK high)	-	-	400 420	W
<b>V2 Output Voltage</b>	All models Load on V2: from 5 to 1000 mA Load on V1: from 0.1 A to I1 rated	11.25	12.5	13.75	V
<b>V2 Output Current</b>	All models	-	-	1	A
<b>5V<sub>SB</sub> Output Voltage</b>	All models (3% set point accuracy)	-	5	-	V
<b>5V<sub>SB</sub> Output Current</b>	All models	-	-	2	A
<b>V1 Load-Line-Cross Regulation</b>	V <sub>AC</sub> : 249 – 528 V <sub>RMS</sub> V1 Load: 0 – 16.7 A (24V) 0 – 11.11 A (36V) 0 – 8.33 A (48V) V2 Load: 0 – 1 A 5V <sub>SB</sub> Load: 0 – 2 A	-	-	±2	%V1
<b>5V<sub>SB</sub> Load-Line-Cross regulation</b>	V <sub>AC</sub> : 249 – 528 V <sub>RMS</sub> V1 Load: 0 – 16.7 A (24V) 0 – 11.11 A (36V) 0 – 8.33 A (48V) V2 Load: 0 – 1 A 5V <sub>SB</sub> Load: 0 – 2 A	-	-	±5	%5V <sub>SB</sub>
<b>V1 Line Regulation</b>	V <sub>AC</sub> : 249 – 528 V <sub>RMS</sub>	-	-	±0.1	%V1
<b>Transient Response (Voltage Deviation) V1, 5V<sub>SB</sub></b>	25% load changes at 1 A/μs 24 V at 1000 μF Load / I <sub>OUT</sub> > 0.5 A 36V at 820 μF Load / I <sub>OUT</sub> > 0.5 A 48V at 560 μF Load / I <sub>OUT</sub> > 0.5 A 5V <sub>SB</sub> at 560 μF Load / I <sub>OUT</sub> > 0.1 A	-	-	±5	%V1 %5V <sub>SB</sub>
<b>V1 Ripple &amp; Noise</b>	All models, Peak-to-peak, 20 MHz BW 100 nF ceramic and 10 μF tantalum caps at the load	-	-	1	%V1
<b>Start-up Rise Time</b>	249 < V <sub>AC</sub> < 528, any load conditions for V1, V2, 5V <sub>SB</sub>	2	-	80	ms
<b>Start-up Delay</b>	V1 in regulation after PS_ON is asserted V1 in regulation after AC is applied 5V <sub>SB</sub> in regulation after AC is applied	-	-	0.2 1.7 1.5	s
<b>Turn-on Overshoot</b>	At 500 mA output current, V1 in regulation within 50 ms	-	10 10 10	-	%V1 %V2 %V <sub>SB</sub>
<b>V1 Hold-up Time</b>	277/347/480 V <sub>AC</sub> , full load 277/347/480 V <sub>AC</sub> , 365 W load 277/347/480 V <sub>AC</sub> , 200 W load	-	16 20 35	-	ms
<b>Minimum Load *</b>	All models; V1, V2 and 5V <sub>SB</sub>	0	-	-	A
<b>V1 Maximum Load Capacitance</b>	277/347/480 V <sub>AC</sub> , 25 °C ambient 24 V 36 V 48 V	-	-	16000 10000 7000	μF

\* When the load on the main output is less than 100 mA, V2 output voltage might regulate below its minimum value. Contact ROAL Electronics for details.

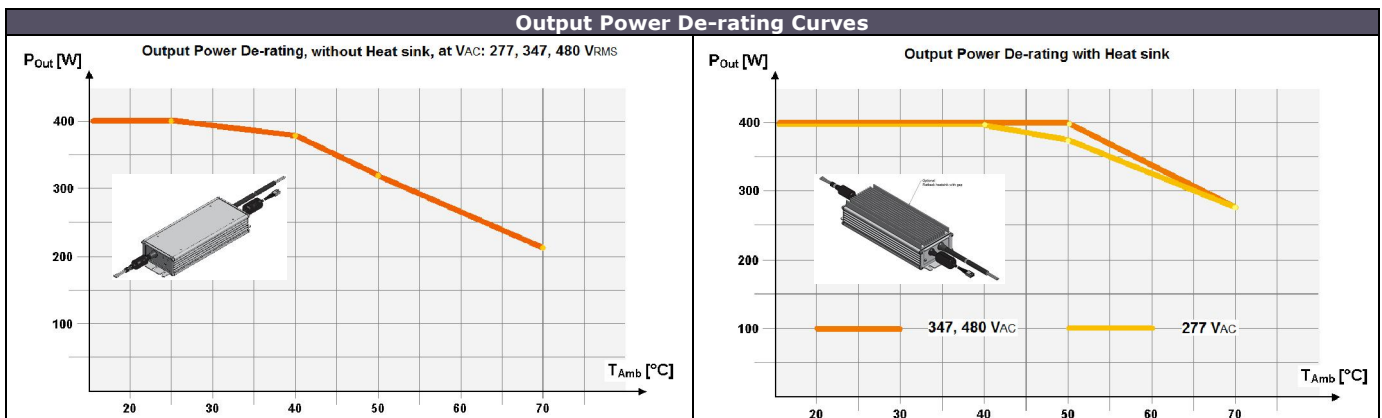

### Eu and RoW

ROAL Electronics S.p.A.  
Via Jesina 56/A  
60022 – Castelfidardo (AN) - Italy  
Tel: +39 071 721461  
Fax: +39 071 72146 480

### North America

ROAL Electronics USA, Inc.  
701, Main St. Suite 405  
Stroudsburg, PA18360  
Phone: +1 570 421 5750  
Fax: +1 570 421 5687  
DS\_DDP400HV Series\_Rev11

## SIGNALS / CONTROLS

Signal	Notes	Min	Typ	Max	Unit
<b>PS_ON</b>	Active low, +5 V TTL signal compatible. Input low voltage	0	-	2.0	V
	Input high voltage ( $I_{IN}= 200 \mu A$ )	3.0	-	-	V
	V1 and V2 disabled when PS_ON is open 5V <sub>SB</sub> not affected by PS_ON				
<b>P_OK</b>	V1 and V2 enabled with PS_ON connected to RTN +5 V TTL compatible				
	Logic level low (<10 mA sinking)	-	-	0.7	V
	Logic level high (100 $\mu A$ sourcing)	2.4	-	5.5	V
	P-OK Delay Time after V1 in regulation (T3 of the below graph)	50	-	100	ms
	Power down warning time	1	-	-	ms
<b>5V<sub>SB</sub> output</b>	Active and in regulation after a $249 < V_{AC} < 528$ is applied	-	-	1.5	s
	5V <sub>SB</sub> not affected by PS_ON				

## SIGNALS TIMINGS

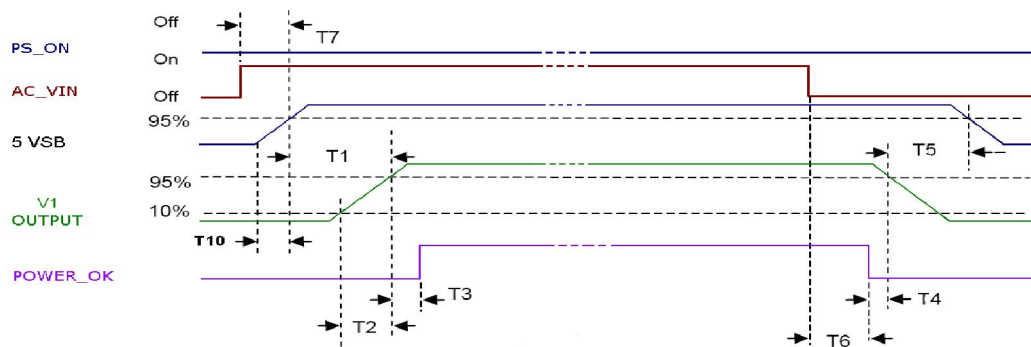

### Above waveforms are expected with AC Input ON/OFF:

5V <sub>SB</sub> On - V1 On	$40 \text{ ms} \leq T1 \leq 200 \text{ ms}$
V1 Rise Time	$2 \text{ ms} \leq T2 \leq 80 \text{ ms}$
5V <sub>SB</sub> Rise Time	$4 \text{ ms} \leq T10 \leq 40 \text{ ms}$
V1 On - Power_OK delay	$50 \text{ ms} \leq T3 \leq 100 \text{ ms}$
Power down warning <sup>1</sup>	$T4 \geq 1 \text{ ms}$
V1off - 5V <sub>SB</sub> Off	$T5 \geq 500 \text{ ms}$ (V1 load > 200 W)
AC Off - P_OK low	$T6 \geq 15 \text{ ms}$ (277/347/480 Vac)
AC_On - 5V <sub>SB</sub> On time	$T7 \leq 1.5 \text{ s}$ (249 to 528Vac)

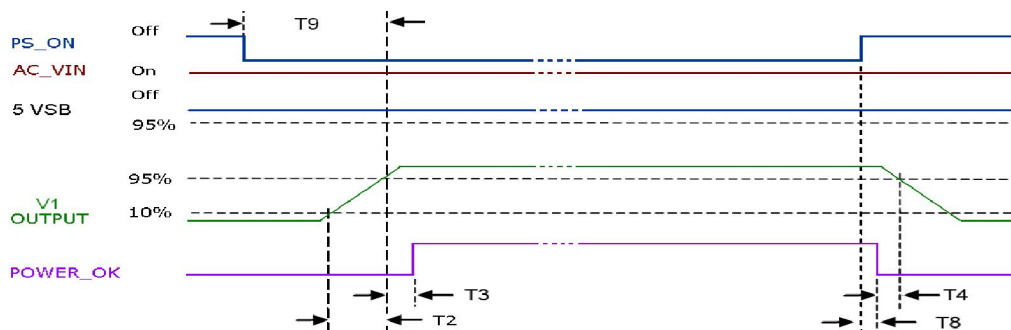

### Above waveforms are expected with PS\_ON Signal ON/OFF state change:

V1 Rise Time	$2 \text{ ms} \leq T2 \leq 80 \text{ ms}$
V1 On - P_OK delay	$50 \text{ ms} \leq T3 \leq 100 \text{ ms}$
Power down warning <sup>1</sup>	$15 \text{ ms} \leq T4 \leq 30 \text{ ms}$
PS_ON - Power down warning	$T8 \leq 2 \text{ ms}$
PS_ON - V1 On delay	$T9 \leq 200 \text{ ms}$

<sup>1</sup> T4 parameter measurement setup will assume 100% of the maximum load on each output (400W max total power).



## PROTECTION FEATURES

Specification	Test Conditions / Notes	Min.	Nominal	Max.	Units
<b>Input Under Voltage Lockout</b>	Auto Recovery, Hiccup Mode	175	195	-	V <sub>AC</sub>
<b>Input Fuse</b>	2X Time Lag, 500 Vac/400Vdc on ACL1 and ACL2	-	-	5.0	A
<b>Over Current 277/347/480 V<sub>AC</sub></b>	V1: Hiccup mode, auto-recovery	106	-	118	%
	V2: PTC limiting, auto-recovery	-	-	-	%
	5V <sub>SB</sub> : Hiccup mode, auto-recovery	125	-	250	%
<b>Short Circuit 277/347/480 V<sub>AC</sub></b>	V1: Hiccup mode, auto-recovery	-	-	-	
	V2: PTC limiting, auto-recovery	-	-	-	
	5V <sub>SB</sub> : Hiccup mode, auto-recovery	-	-	-	
<b>Over Voltage</b>	V1: Hiccup mode, auto-recovery	125	-	140	%V <sub>NOM</sub>
	5V <sub>SB</sub> : Hiccup mode, auto-recovery	120	-	160	%V <sub>NOM</sub>
<b>Over Temperature (on primary stage)</b>	Shut down, latch off	-	-	-	
<b>Over Temperature (on secondary side)</b>	Hiccup mode with auto-recovery	-	-	-	
<b>Isolation Input-Output</b>	Reinforced Not tested in production	4242	-	-	V <sub>DC</sub>
<b>Isolation Input to Earth</b>	Basic	2780	-	-	V <sub>DC</sub>



## ENVIRONMENTAL SPECIFICATIONS

Specification	Test Conditions / Notes	Min	Nominal	Max	Units
<b>Operating Temperature Range</b>		-35	-	50	°C
<b>De-rated Operating Temperature Range</b>	Without heat-sink (277/347/480 V <sub>AC</sub> ) 400W at 25 °C 375W at 40°C Linear derating from 40°C to 70°C 320W at 50°C 215W at 70°C				
	With heat-sink (480 V <sub>AC</sub> ) 400W up to 50°C Linear derating from 50°C to 70°C 275W at 70 °C				
<b>Storage Temperature Range</b>		-40	-	85	°C
<b>Humidity</b>	RH, Non-condensing Operating	-	-	90	%
	Non-operating	-	-	95	%
<b>Operating Altitude</b>		-	-	4000	m
<b>Shock</b>	<b>EN 60068-2-64</b> Operating: 5-500 Hz, 1 GRMS (0.002 g <sup>2</sup> /Hz), 3 axes, 30 min. Non-Operating: 5-500 Hz, 2.46 GRMS (0.0122 g <sup>2</sup> /Hz), 3 axes, 30 min.				
<b>Vibration</b>	<b>EN 60068-2-27</b> Operating: 30 G /18 ms HALF SINE, 3 axes, 6x axes (3 positive and 3 negative). Non-Operating: 50 G /11ms HALF SINE, 3 axes, 6x axes (3 positive and 3 negative).				
<b>MTBF</b>	277/347/480V <sub>AC</sub> , Full load, 40°C ambient 80% Duty cycle, Telcordia SR-332 Issue 2	-	400000	-	Hours
<b>Useful Life</b>	277/347/480 V <sub>AC</sub> 300 W, 40°C ambient, natural convection	-	52000	-	Hours
	300 W, 25°C ambient, natural convection	-	145000	-	Hours
<b>Cooling</b>	Convection with or without heat-sink and conduction providing an adequate thermal path between the unit and the external environment. Case hot spot temperature T <sub>c</sub> shall not exceed 90 °C in any working condition.				





## ELECTROMAGNETIC COMPATIBILITY (EMC) - EMISSIONS

Phenomenon	Conditions / Notes	Standard	Equipment Performance Class
<b>Conducted</b>	277/347/480 V <sub>AC</sub> , full load	FCC Part 15	B
		EN55022 EN55015	B
<b>Radiated</b>	At 10 m distance	FCC Part 15	B
		EN55022 EN55015	B
<b>Line Voltage Fluctuation and Flicker</b>	277/347/480 V <sub>AC</sub> At 20%, 50% and 100% rated load	EN 61000-3-3	
<b>Harmonic Current Emission</b>	277/347/480 V <sub>AC</sub> All load conditions > 100 W	EN 61000-3-2	C



## ELECTROMAGNETIC COMPATIBILITY (EMC) - IMMUNITY

Phenomenon	Conditions / Notes	Standard	Test Level	Performance criteria
<b>ESD</b>	15 kV air discharge, 8 kV contact, at any point of the system.	EN 61000-4-2	4	A
<b>Radiated Field</b>	3 V/m, 80-1000 MHz, 1 KHz 80% AM	EN 61000-4-3	3	A
<b>Electric Fast Transient Surge</b>	±2 kV on AC power port for 1 minute.	EN 61000-4-4	3	A
<b>Surge</b>	± 4kV line to line, ± 6 kV line to earth on AC power port.	EN 61000-4-5		B
<b>Conducted RF Immunity</b>	3 V <sub>RMS</sub> , 0,15-80 MHz, 1 kHz 80% AM	EN 61000-4-6	3	A
<b>Dips and Interruptions</b>	Drop-out to 0% for 10 ms	EN61000-4-11		A
	Dip to 40% for 5 cycles (100 ms)	EN61000-4-11		B
	Dip to 70% for 25 cycles (500 ms)	EN61000-4-11		B
	Interrupts > 95% for 5 s	EN61000-4-11		B



## SAFETY AGENCIES APPROVAL

Certification Body	Safety Standards and file numbers
<b>CSA/UL</b>	 - UL Recognized (E330583.FKSZ2,8) according to UL 8750 and CSA C22.2 No 250, suitable for dry and damp locations, rated HL, meaning Class I, Division 2 hazardous (Classified) location luminaires. Auxiliary output, I/O signals and stand by output are Class 2 rated.
<b>CE</b>	CE Mark for EU according to EN 60950-1: 2006/A11:2009, EN 60950-1:2006/A12: 2011, EN 60950-1:2006/A1: 2010, EN 60950-1: 2006/A2: 2013, EN 60950-1: 2006

## OUTLINE DRAWING AND CONNECTIONS \_ SEALED BOX

<b>Overall dimensions:</b>	Without heat-sink	(93.6 X 258.0 X 44.5) mm; (3.69 X 10.16 X 1.75) in
	With heat-sink	(93.6 X 258.0 X 59.2) mm; (3.69 X 10.16 X 2.33) in
<b>Weight:</b>	Without heat-sink	1900 g; 4.188 lb
	With heat-sink	2185 g; 4.817 lb

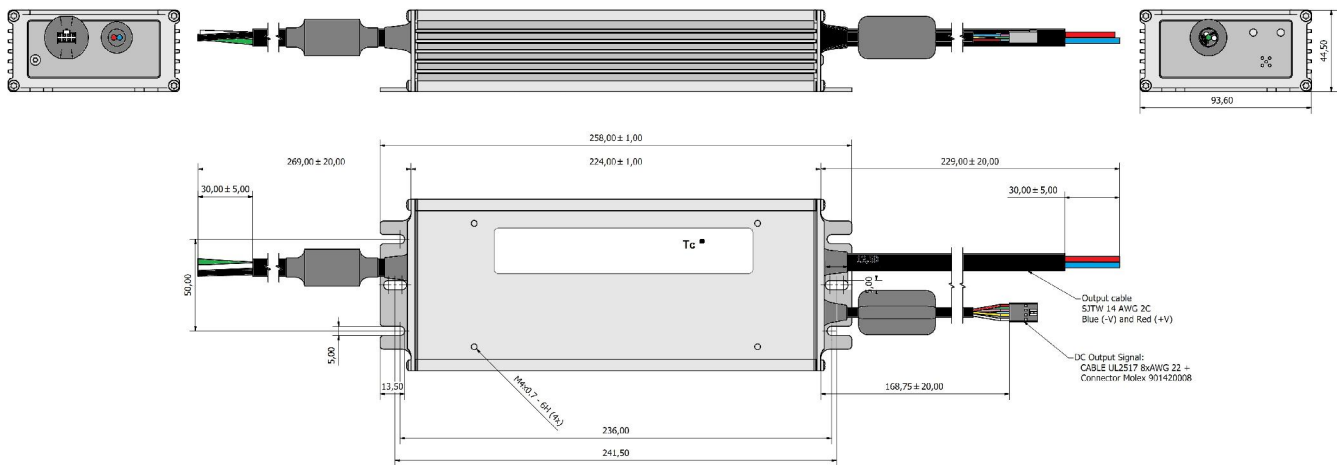

Connections	Wires Gauge and Length	Assignment	Colour / Pin
<b>AC Input</b>	STW 3X 18AWG, 105 °C – 600 V, water resistant 60 °C, stranded wires, 269.0 ± 20 mm extension from chassis.	AC L1	Black
		AC L2	White
		Protective Earth (PE)	Green
<b>DC Output</b>	SJTW 2X14 AWG 105°C/300V, water resistant 60 °C, stranded wires, 229.0±20 mm from chassis.	+V1 Output (+V1)	Red
		V1 Return (RTN)	Blue
<b>Auxiliary Voltages Control Signals</b>	Wires: SJTW 8X 22AWG, 105°C - 300V, water resistant 60°C, black external insulation, 169±20mm extension from chassis to connector.  Housed by Connector: Molex 90142-0008 Terminals: Molex 90119-0109 (Tin plating)  Mates with Molex 90130-1106 or equivalent. Terminals: Tin plating termination	+5 V Stand-by Output (+5V <sub>SB</sub> )	Red – 1
		Output Power Good (P_OK)	Green – 2
		- Fan Voltage (-V2)	Brown – 3
		Remote On/Off (PS_ON)	Grey/Purple – 4
		+ Terminal Remote Sense (+RS)	Yellow – 5
		Stand-by/Signals Return (RTN)	Blue – 6
		+ Fan Voltage (+V2)	White – 7
		Stand-by/Signals Return (RTN)	Black – 8

Roal Electronics, S.p.A. may change product specifications and accordingly the information presented in this document. Customers are responsible for their products and applications using Roal Electronics, S.p.A. products. Roal Electronics, S.p.A. assumes no liability from the use of its products outside of specifications. No license is granted to any intellectual property rights by this document. ROAL ELECTRONICS, S.P.A. DISCLAIMS ALL REPRESENTATIONS AND WARRANTIES OF ANY KIND, EXPRESS OR IMPLIED, INCLUDING, BUT NOT LIMITED TO, IMPLIED WARRANTIES OF NONINFRINGEMENT, MERCHANTABILITY AND FITNESS FOR A PARTICULAR PURPOSE.

### Eu and RoW

ROAL Electronics S.p.A.  
Via Jesina 56/A  
60022 – Castelfidardo (AN) - Italy  
Tel: +39 071 721461  
Fax: +39 071 72146 480

### North America

ROAL Electronics USA, Inc.  
701, Main St. Suite 405  
Stroudsburg, PA18360  
Phone: + 1 570 421 5750  
Fax: +1 570 421 5687  
DS\_DDP400HV Series\_Rev11